

CPQ quote: QUO0000005520 Rev: 0

Date & revision: 2022-01-25 rev.0

General exterior	page 2
Curbside exterior	page 3
Streetside exterior	page 4
Front & rear exterior	page 5
Curbside interior wall	page 6
Streetside interior wall	page 7
Front interior wall	page 8
Rear interior wall	page 9
Floor view	page 10
Ceiling view	page 11
Front console	page 12
Rear streetside console	page 13
Floor console details	page 14

DISCLAIMERS

Demers makes every effort to maintain the accuracy and quality of the information provided in these drawings. However, Demers cannot guarantee and assumes no legal liability or responsibility for the accuracy or completeness of the information provided. The information contained in these drawings is for general guidance only. You should always develop your quote and send to Demers for engineering validation to the feasibility of the custom options according to the specific configuration required by the customer.

Should there be any discrepancies between the CPQ configurator, the CPQ quote or sale sheet and these drawings; the CPQ configurator, the CPQ quote or sale sheet will take precedence. These drawings are subject to change by engineering during the construction process of the vehicle. Dimensional data for information only. The copyright of all content in these drawings is owned by Demers and/or the various manufacturers of our equipment. These drawings in part or whole cannot be changed, reproduced, stored in or transmitted onto any website or social media without the prior written consent from Demers.

MXP170E - Ford F450 MacQueen Emergency Demo



General exterior

Date: 2022-01-25 rev.0
Scale: 1:45
Draftman: BL

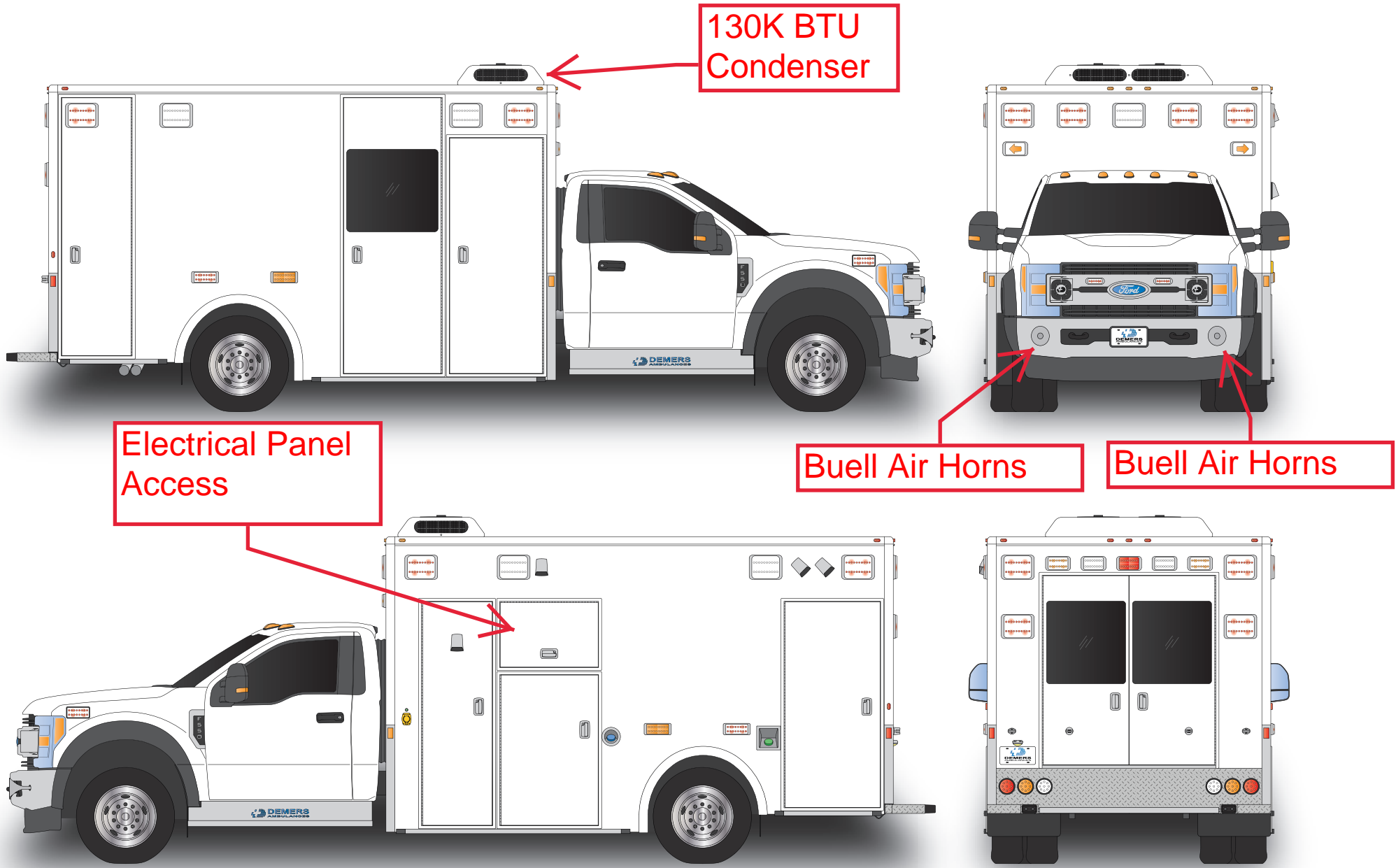

Curbside exterior

Can Be Configured with In/out access, Stairchair storage, or SCBA Storage

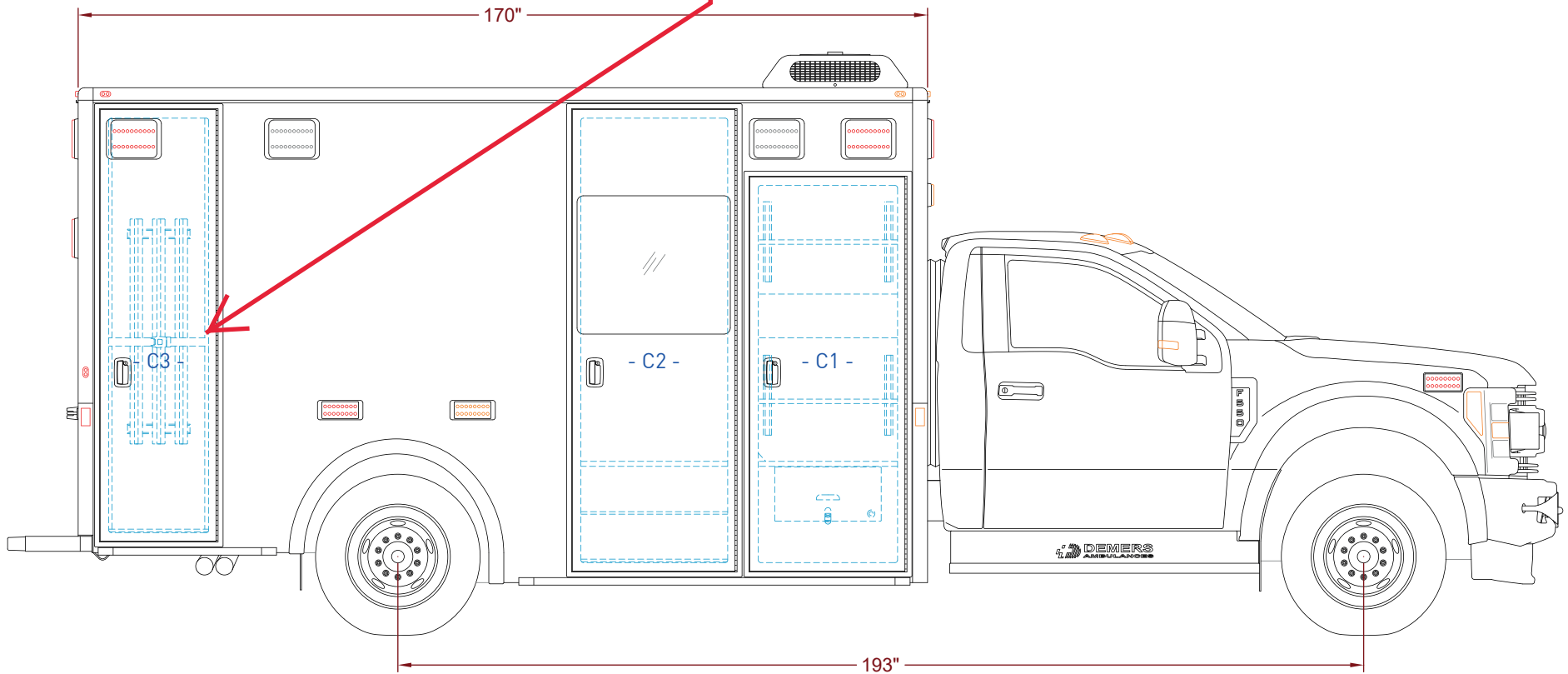

Compartment	Opening L x H	Interior dimensions L x H x D
C1	27.75" x 55.75"	30.25" x 57.25" x 32.00"
C2	29.25" x 88.75"	-
C3	20.00" x 82.75"	20.75" x 84.25" x 18.50"

Can Be Configured with SCBA Storage, Full Compartment Storage, Closed off In/Out

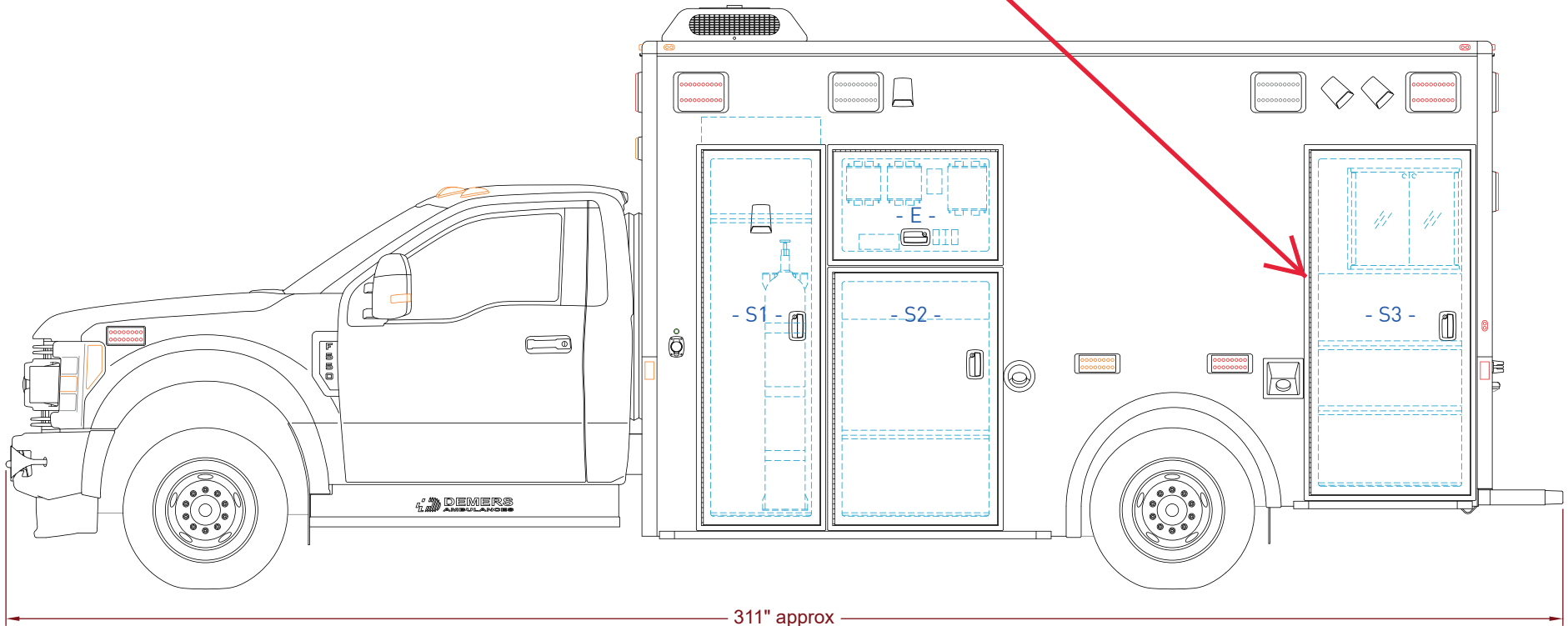

Compartment	Opening L x H	Interior dimensions L x H x D
S1	20.25" x 71.50"	23.75" x 79.50" x 18.00"
S2	29.25" x 47.00"	32.25" x 47.25" x 13.50"
S3	28.50" x 65.50"	33.25" x 42.00" x 17.50"
E	29.25" x 18.50"	-

Front & rear exterior

Date: 2022-01-25 rev.0
 Scale: 1:32
 Draftman: BL

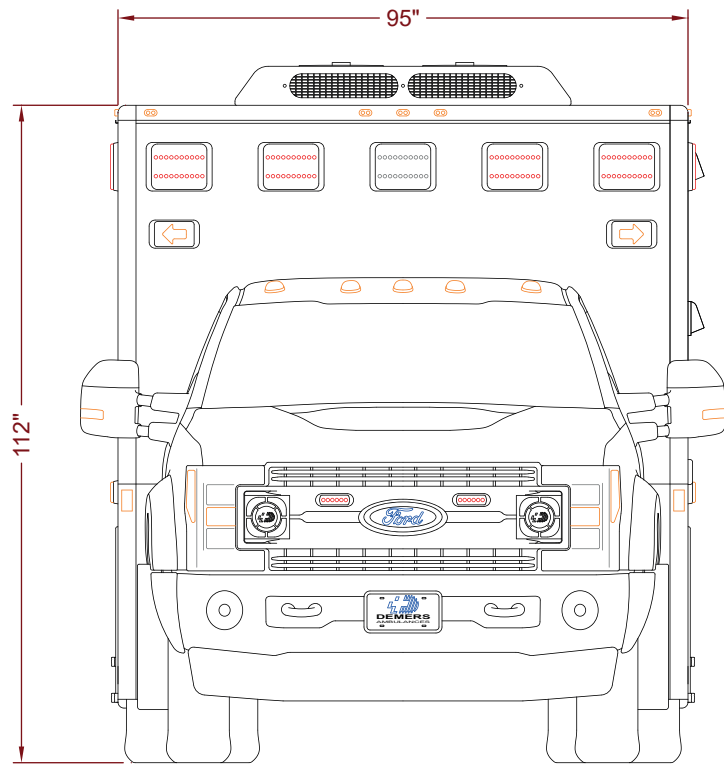

Note

The total height of the vehicle can be different according to chassis and suspensions

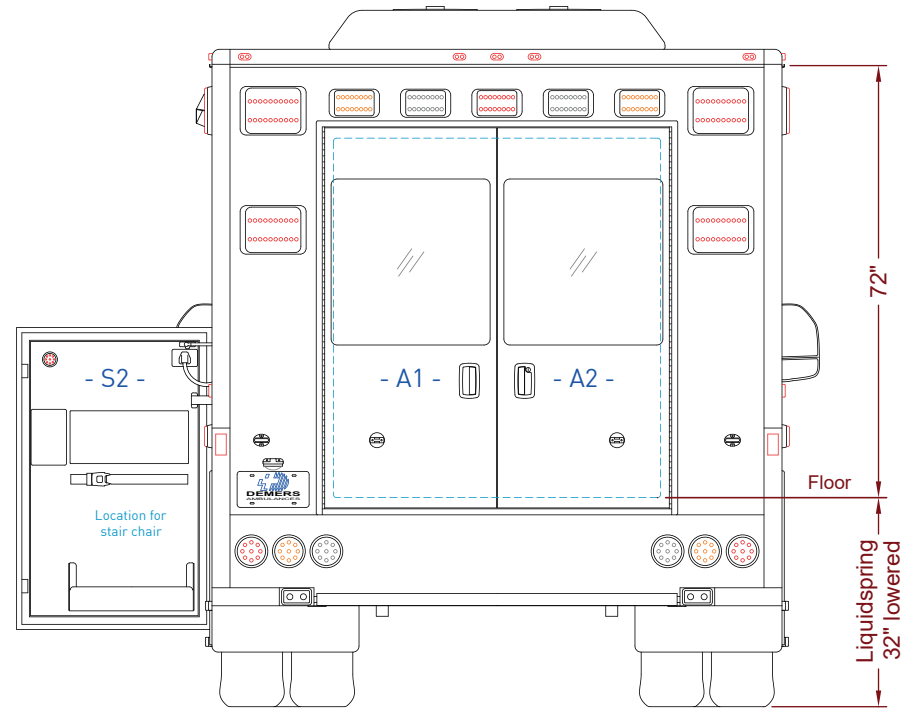

Note

The rear loading height of the vehicle can be different according to chassis and suspensions

Compartment	Opening L x H	Interior dimensions L x H x D
A1 & A2	54.50" x 59.75"	-

Curbside interior wall

Date: 2022-01-25 rev.0
 Scale: 1:20
 Draftman: BL

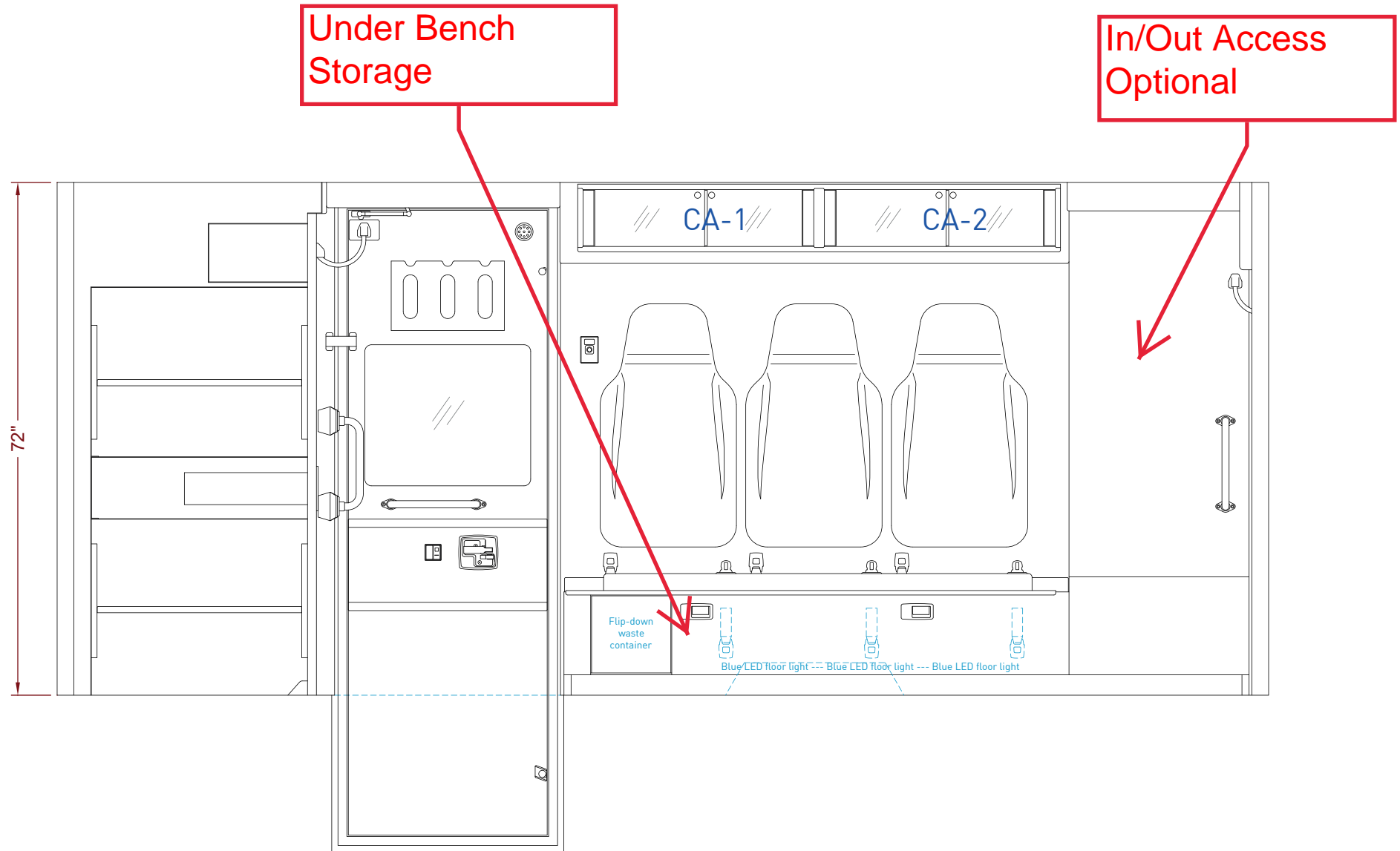

Compartment	Opening L x H	Interior dimensions L x H x D
Storage cabinet -NS1-	32.25" x 8.00"	33.50" x 9.50" x 8.50"

Streetside interior wall

Date: 2022-01-25 rev.0
 Scale: 1:20
 Draftman: BL

Heat Vents Span the Floor to Heat Patient First

A/C Vents

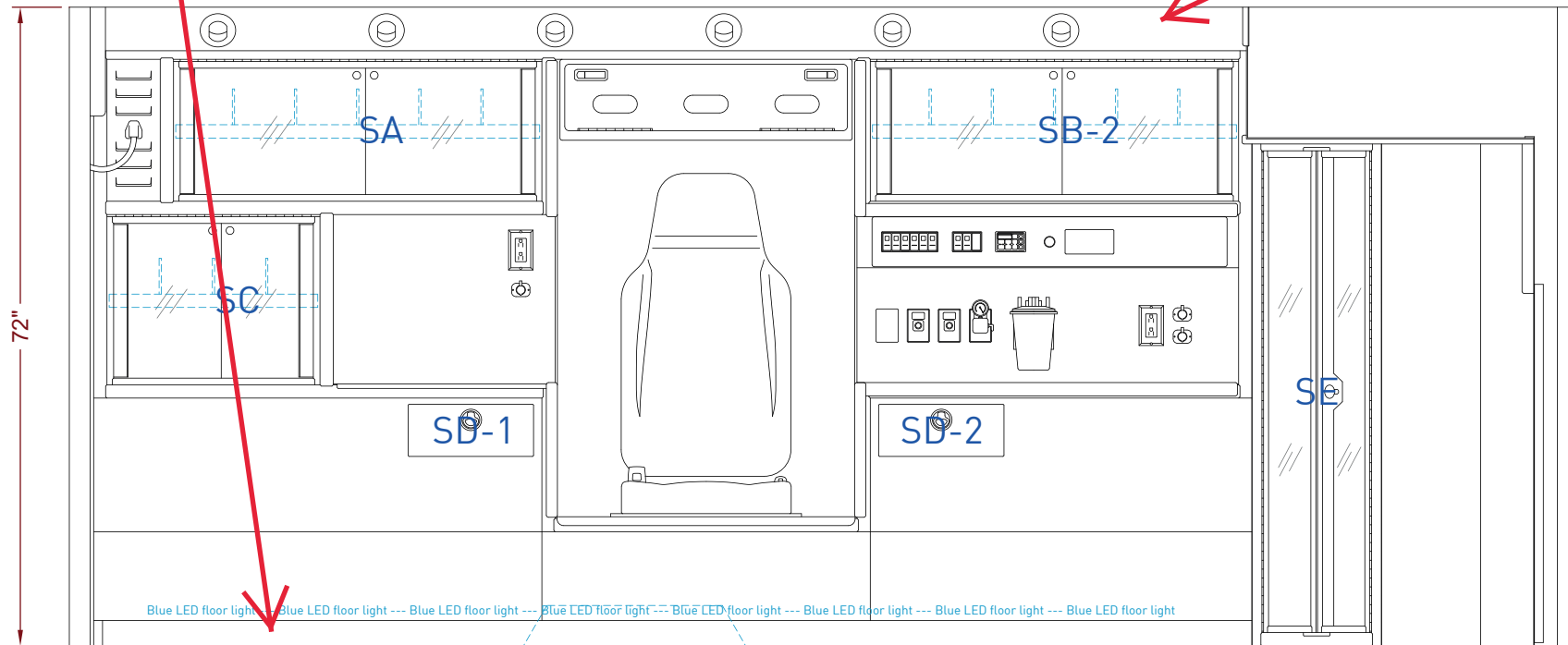

Compartment	Opening L x H	Interior dimensions L x H x D
Storage cabinet -SA-	41.50" x 16.00"	42.50" x 16.75" x 16.00"
Storage cabinet -SB-	41.50" x 16.00"	41.75" x 16.25" x 11.00"
Storage cabinet -SC-	24.00" x 19.25"	25.00" x 20.25" x 16.00"
Storage cabinet -SD-	-	12.00" x 4.50" x 12.50"
Storage cabinet -SE-	16.50" x 54.25"	*25.50" x 57.25" x *15.75"

* This dimension is the maximum

Front interior wall

Date: 2022-01-25 rev.0
 Scale: 1:20
 Draftman: BL

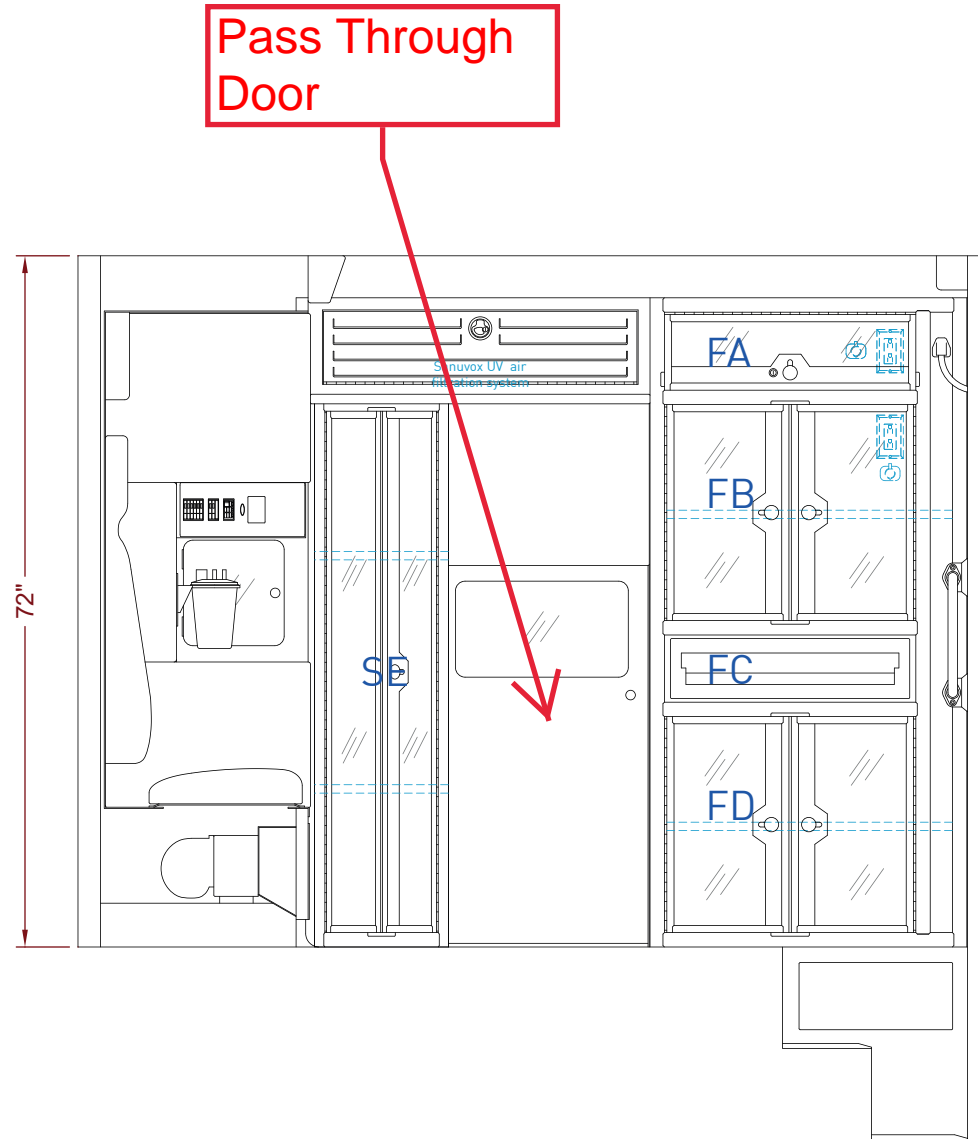

Compartment	Opening L x H	Interior dimensions L x H x D
Lockable comp. -FA-	26.00" x 8.00"	26.00" x 8.00" x 13.75"
High ALS comp. -FB-	26.00" x 22.50"	32.00" x 23.75" x 30.25"
Storage drawer -FC-	-	21.75" x 4.50" x 18.50"
Low ALS comp. -FD-	26.00" x 22.50"	32.00" x 24.75" x 30.25"

Rear interior wall

Date: 2022-01-25 rev.0
Scale: 1:20
Draftman: BL

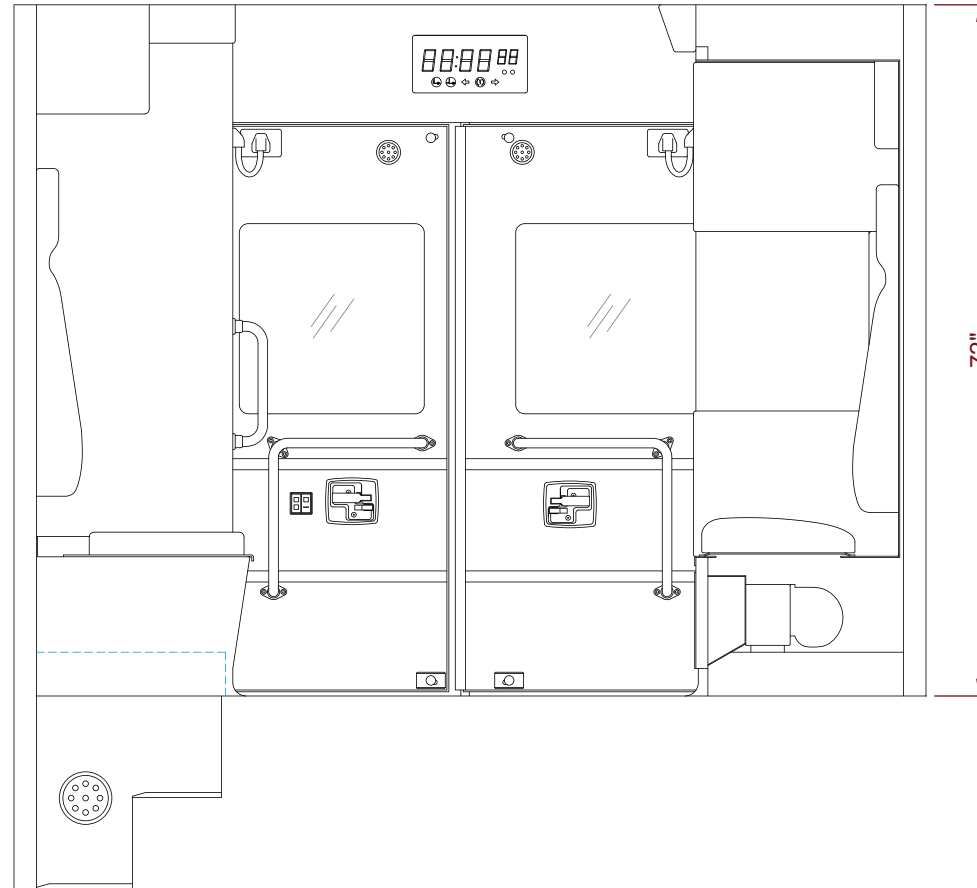

Floor view

Date: 2022-01-25 rev.0
Scale: 1:32
Draftman: BL

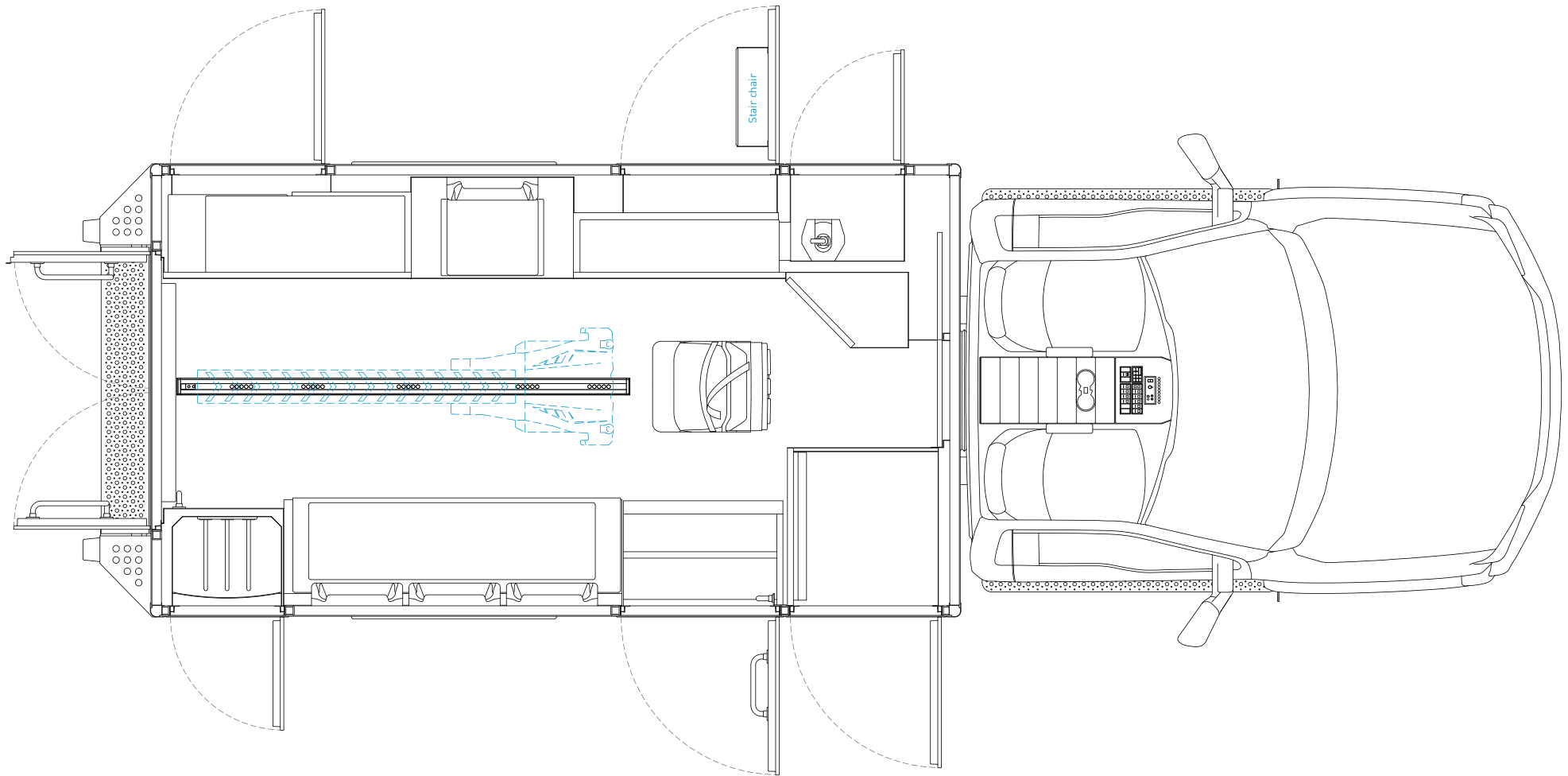

Ceiling view

Individually
Ducted A/C Vents

U/V Light Air
Filtration System

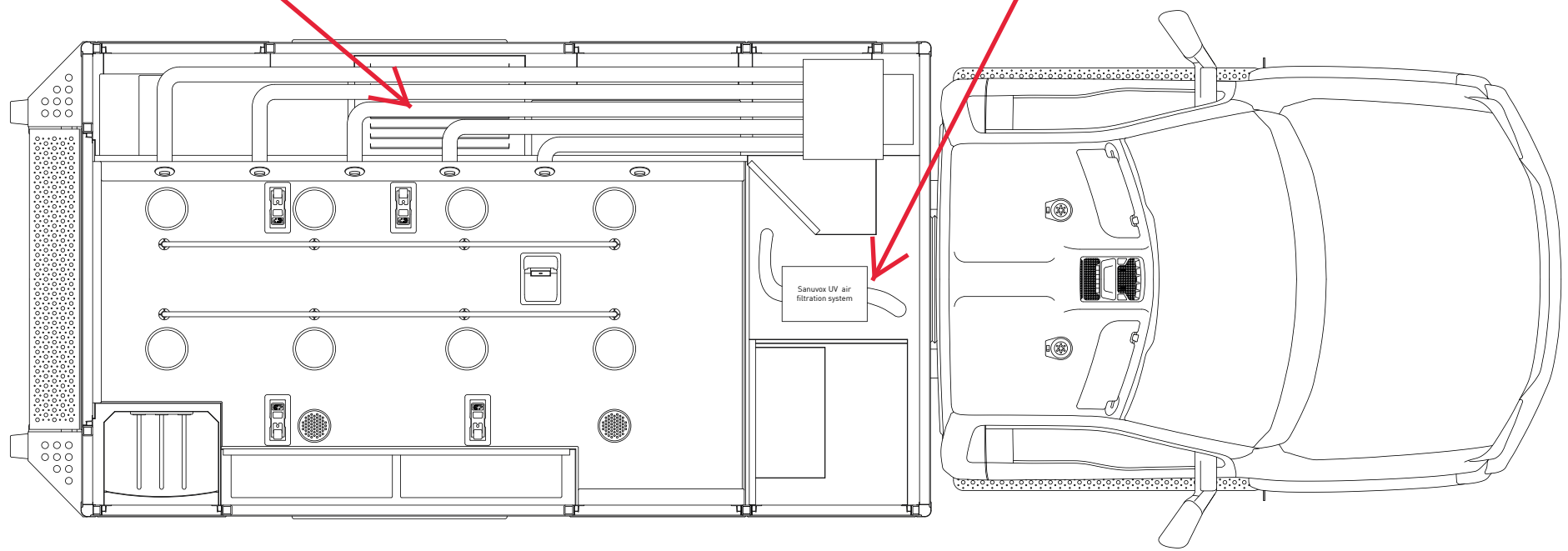

Front console

Date: 2022-01-25 rev.0
Scale: 1:3
Draftman: BL

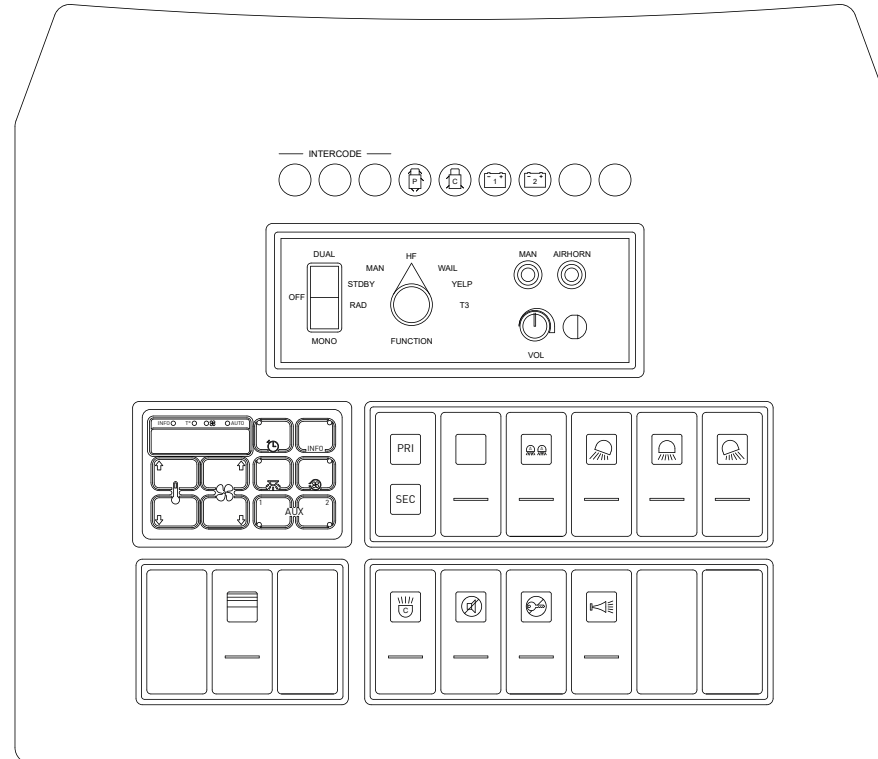

Rear streetside console

Date: 2022-01-25 rev.0
Scale: 1:3
Draftman: BL

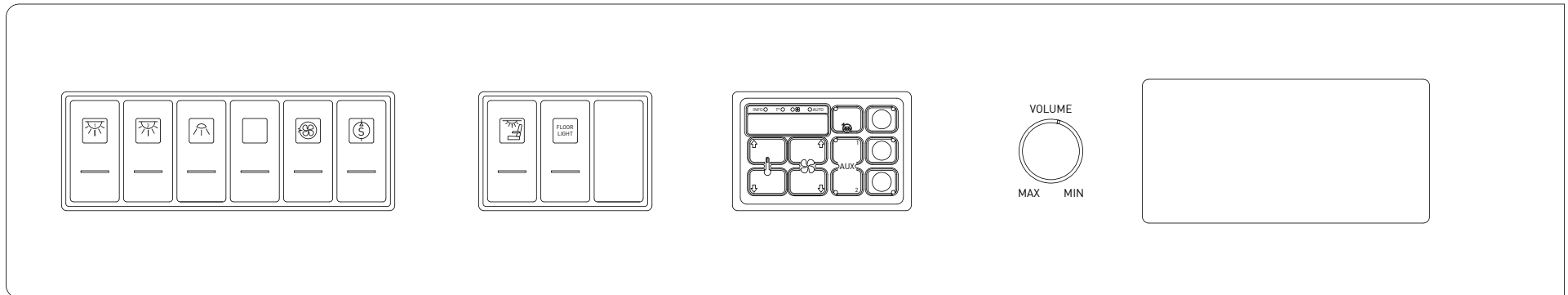

Floor console details

Date: 2022-01-25 rev.0
Scale: 1:7
Draftman: BL

Top view

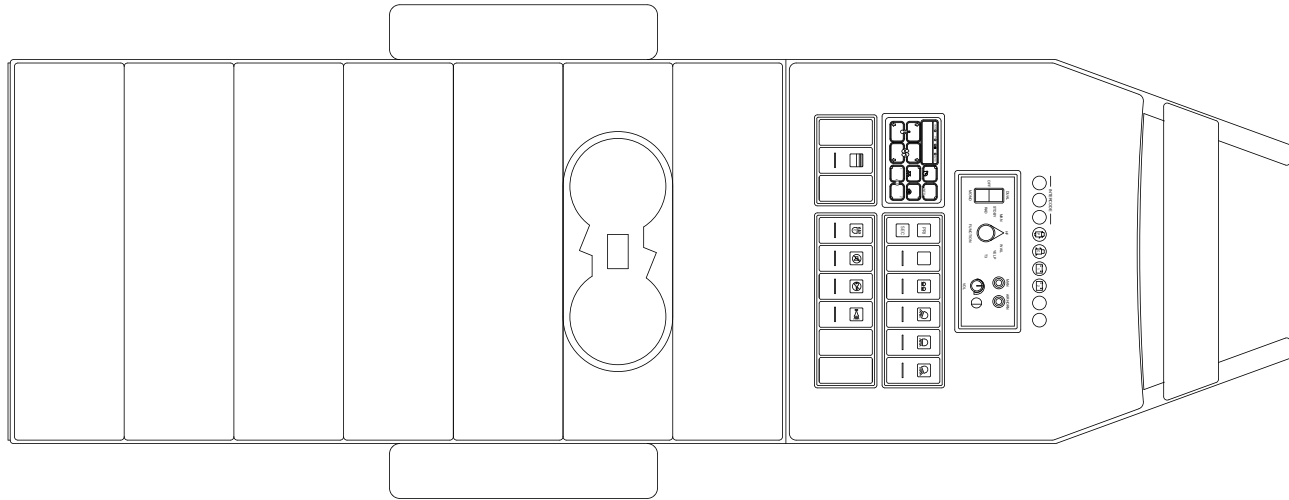

Side view

